



VMAP

Standards Community e.V.

1ST VMAP

USER MEETING

2024

CONFERENCE PROCEEDINGS

14 & 15 FEBRUARY 2024

SCHLOSS BIRLINGHOVEN, SANKT AUGUSTIN, GERMANY

TABLE OF CONTENTS

The VMAP Standards Community.....	6
VMAP IO Library Overview	7
VMAP Working Group – Full Model Storage: Breaking the communication barriers among different solvers.....	8
VMAP Working Group – SENSOR DATA Storage	9
VMAP Working Group – Visualization of VMAP Data Sets	11
Integration of measurement data into the simulation workflow for blow-molded plastic parts using the VMAP interface standard.....	12
Furnace modelling - Sharing the experience for data analytics and modelling in the steel production domain	13
Virtual manufacturing validation data in composite production	14
Archiving of data sets in the NDT (Non-destructive Testing)	15
Ultrasonic Guided Waves data in SHM design	16
Scalable principles for integration pipelines of sensor data and simulations using knowledge graphs	17
VMAP-enabled multi-disciplinary collaboration on jet engine design	19
Semantic concepts to store and access VMAP-based simulation data	21
The application of the VMAP standard in virtual process chains for continuous fiber reinforced polymers.....	22
Standardized Simulation Workflows in the Automotive Industry.....	23
Process Automation for CAE Engineers	24
Project PIONEER - Open platform for optimising production systems.....	25
Integrated design process for flexible electronics using VMAP	27
Project Metafacturing - Data and Metadata for Advanced Digitalization of Manufacturing Industrial Lines	28
Project RESTORE - Sustainable Remanufacturing solution with increased automation and recycled content in LASER and Plasma based process	29
PROJECT ALABAMA - Adaptive Laser Beam for Additive Manufacturing	30

TABLE OF CONTENTS

PROJECT BASE - Battery Passport for Resilient Supply Chain and Implementation of Circular Economy	31
Integration platforms for Digital Product Passports.....	32
FAIR Data in Platform MaterialDigital (PMD): Ontologies, Semantic Data Integration and Data Exchange	33
MODA and CHADA: Standardization and digitalization of Simulation and Characterization Data in Materials Science .	34
STEP by STEP to a Model-Based Enterprise.....	35
Become a member of VMAP SC!	36

THE VMAP STANDARDS COMMUNITY

The lack of software standards in virtual engineering workflows and incompatible interfaces for the transfer of virtual data not only cause additional costs and complex manual adaptation but also lead to inflexible IT solutions, loss of information and significant delays in the overall design process. The standardization of data interfaces in CAE is therefore vital for all industry segments where simulation processes are central to the product and process design.

In December 2022 sixteen founding members – partially coming from the initial ITEA project – established the VMAP Standards Community (VMAP SC), registered as a not-for-profit association. The VMAP SC association promotes science and research. It is concerned with the scientific investigation of the application possibilities as well as further development and maintenance of an open software standard that can be used for industrial and academic applications in a generally and free accessible manner. VMAP SC is open to all interested parties who wish to use or contribute to the standardization efforts of the association. The association wishes to carry the VMAP standardization efforts into the future.

In particular, at the time of the foundation of this association there are still open scientific questions concerning at least the following technical disciplines:

- Storage of complete simulation models and consideration of further simulation disciplines and discretization methods
- Connection to product management and design data,
- Linking of virtual simulation data with real measurement and sensor data,
- Semantic and cross-disciplinary organization of data via ontologies,
- Support for AI-based analysis and prediction methods.

A solution to these and future questions is to be made possible by the association within the framework of current R&D projects or projects still to be developed. In this context, projects/project applications/funding programs of various research institutes are to be linked.

The association's activity is aimed at making the results of scientific activity accessible to the general public, which is usually done by publishing them.

VMAP IO LIBRARY OVERVIEW

Priyanka Gulati,
Fraunhofer Institute for Algorithms and Scientific Computing – SCAI, Sankt Augustin GERMANY

VMAP is a vendor-neutral standard for CAE data storage to enhance interoperability in virtual engineering workflows.

Most of the CAE Software tools are rarely interoperable and contain multiple native formats for storing the CAE data to be transferred between simulation codes. The corresponding lack of standardisation means that companies must implement customised data transfer solutions – a huge effort in terms of both time and money. The VMAP standard has filled this gap by creating the world’s first CAE workflow interface standard. This is completely open to any interested party, helping to maximise its uptake amongst companies of all sizes. Input/output (I/O) routines have also been provided for easy implementation. With the uptake of this standard, VMAP’s end-users will enjoy a faster time to market and lower production costs through a decrease in the amount of manual work and corresponding human error in their CAE workflows.

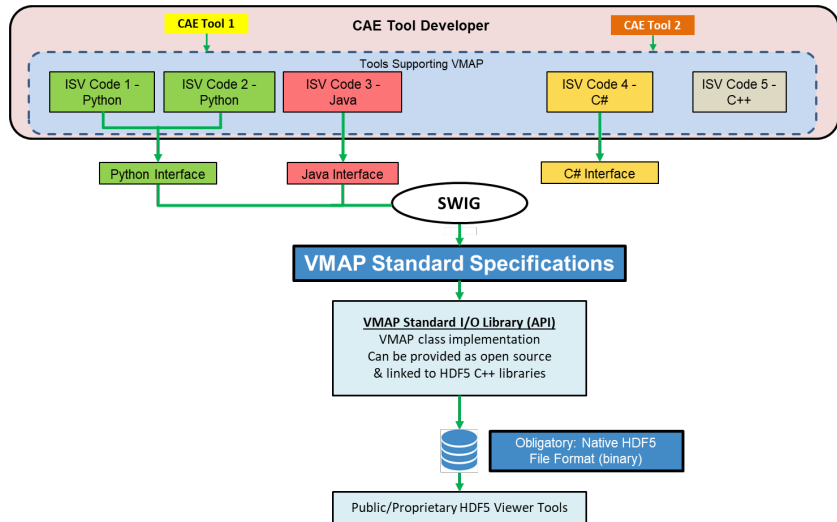

Figure 1: VMAP IO Lib Architecture.

The VMAP specification is based on HDF5 API which is a widely accepted implementation platform for many IO related applications. The VMAP IO library includes bindings for most programming and script languages. It consists of definitions for meta-information, unit and coordinate systems, mesh geometry and discretization, a fast-growing number of element and integration rule definitions, physical result quantities, and finally also common concepts to transfer virtual material model parameters. The VMAP Standard Specifications is available for download from the vmap-standard.org website and the VMAP I/O Library is licensed by the association to interested parties on a royalty free basis.

VMAP WORKING GROUP – FULL MODEL STORAGE: BREAKING THE COMMUNICATION BARRIERS AMONG DIFFERENT SOLVERS

*Thanasis Fassas,
BETA CAE Systems SA, Epanomi, Greece*

Working Group Members: BETA CAE, HTW Berlin BMW, FhG SCAI, DLR

It is a common situation, when working on multidisciplinary workflows, that several solvers are involved. One of the main characteristics of these processes is that the input for each of the involved solvers is the result file from a previous step. Consequently, engineers monitoring such processes must know how to use all these different solvers.

In particular, the engineers not only need to be able to set up a model for each solver, but also need to recognize and fix any incompatibility arising from a previous step. Unfortunately, this increases the complexity of an already demanding process.

Setting up a model in one pre-processor and pushing this same file format to different solvers would significantly facilitate such processes.

Using such a solver file format reduces a lot of procedural time. First of all, engineers do not have to define different files for each involved solver. Furthermore, it reduces the effort for learning all necessary solver formats. It also hides the complexity of the process since the incompatibilities among the different solver formats are eliminated.

As a result, it improves and speeds up the cooperation among all the departments participating in the process.

The capability to use one format, allows for more effective working ways. Adopting a new way of setting up a model, however, might cause result in extra effort. This fact raises the question of whether the benefits of the new approach would justify this extra effort. Thus, it is more than obvious the need for a pre-processor that supports this new era.

In this presentation, on the one hand, we will demonstrate the usage of the VMAP format in complex workflows and support the setup of an interoperable solver file. On the other hand, we will examine how a multidisciplinary pre-processor with solver interoperability capabilities can facilitate this new approach and allow the user to get the full benefits of this new VMAP.

VMAP WORKING GROUP – SENSOR DATA STORAGE

Victor Lüddemann

Fraunhofer Institute for Algorithms and Scientific Computing – SCAI, Sankt Augustin GERMANY

Working Group Members: Hagen Stiftung, HS BRS, SWERIM, FhG SCAI, DLR

Figure 2 shows a representation of the measurement procedure with comprehensive aspects of measurement data. The data are formally divided into two categories. The elements depicted in red are standardized datasets. On the one hand, these include the full measurement result, consisting of the measured

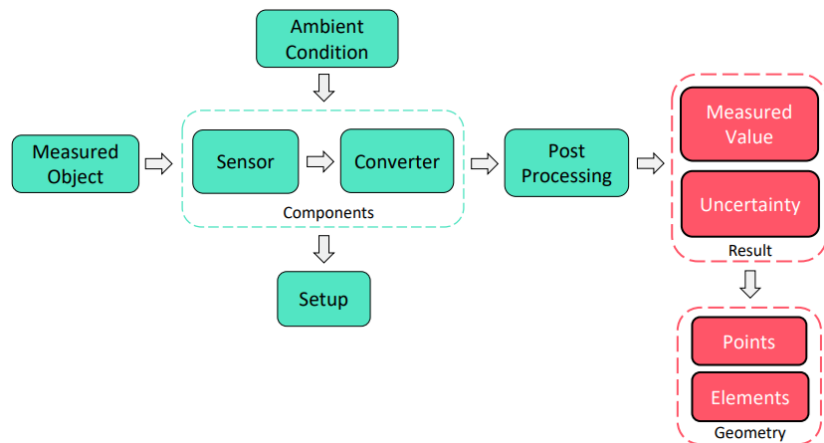

Figure 2 : Comprehensive measurement data in a measurement procedure with datasets (red) and metadata (green).

value and the measurement uncertainty, and on the other hand, measurement points, to which the measurement result is assigned. Additional information about the measurement, such as descriptions of the measurement setup, the measurement object, influencing factors, and post-processing methods, is shown in green.

The suggested MEASUREMENT group is divided into four subgroups, each containing different parts of the data for a given measurement procedure. Each procedure is therefore assigned to its own group <n>, with <n> being a reference index. Figure 3 shows how the measurement data concept is integrated into VMAP alongside simulations. Measurements that have been taken for comparison purposes can thus be stored together with the respective simulation model.

A suggestion of how datasets, addressing uncertainties and statistics in measurement results, could be integrated into the VMAP structure is depicted in Figure 4.

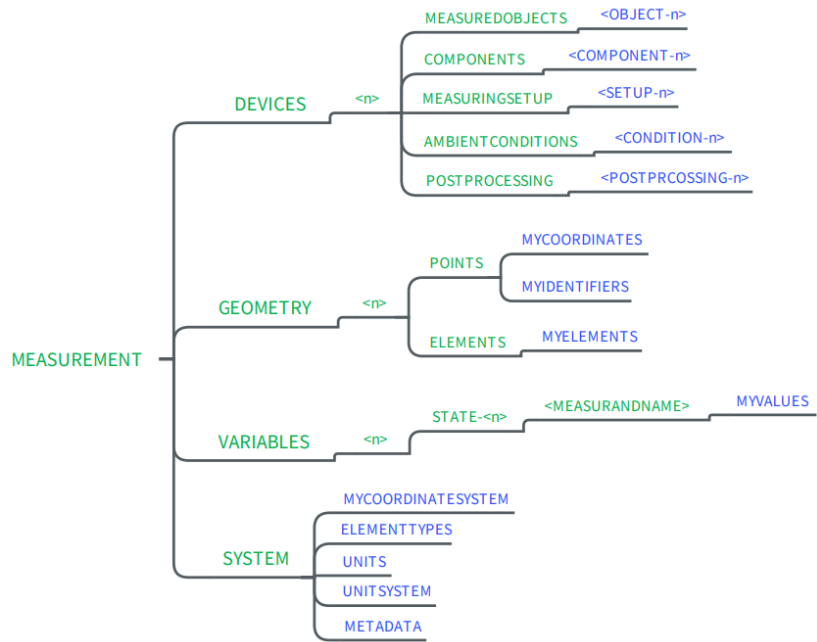

Figure 3: Suggested VMAP structure for measurement data.

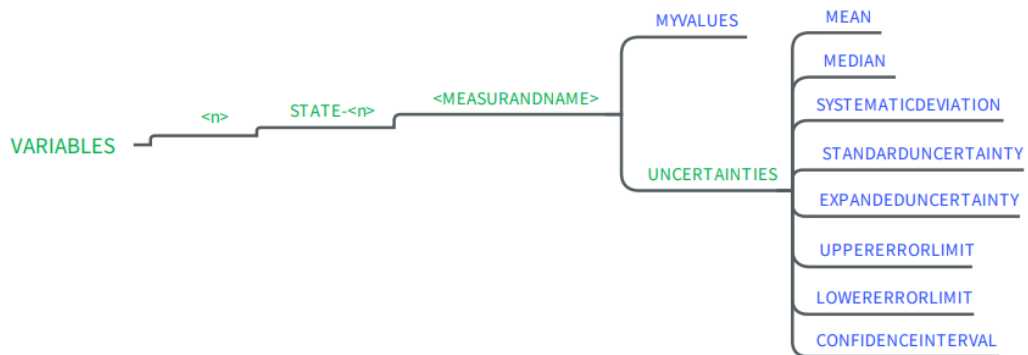

Figure 4: Proposal for including uncertainties of measurement results.

VMAP WORKING GROUP – VISUALIZATION OF VMAP DATA SETS

Andre Oeckerath

Fraunhofer Institute for Algorithms and Scientific Computing – SCAI, Sankt Augustin GERMANY

Working Group Members: FhG SCAI, HagenStiftung, Reden, KIT, Convergent

This working group in VMAP SC is focussing on development of a VMAP plug-in for the Paraview, an open-source multiple-platform application for interactive, scientific visualization.

The following functionalities have been implemented based on some of the use cases and feedback from the VMAP

Analytics project:

- Multiple parts
- Individual part and variables selection
- Static or transient variables
- Variables on nodes, elements, or integration points (averaged to elements)
- Scalars, vectors, and 2nd order symmetric tensor (visualized as von Mises)
- Partial results
- Deformed geometry via DISPLACEMENT variable

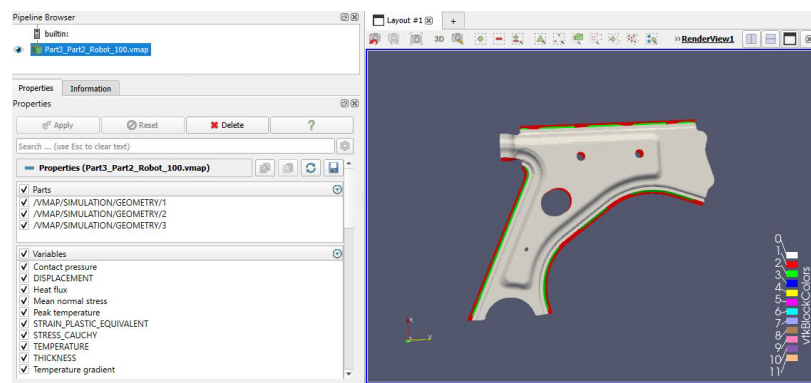

Figure 5: Paraview displaying a part stored in VMAP format

The further extension of the plug-in is still ongoing and some of the items which will be implemented in the next months include, tensor component visualization, multiplicity > 1 variables, e.g., element coordinate system stored in ORIENTATION, layered visualization of integration point results, measurement data on point clouds, with geometry and tables.

INTEGRATION OF MEASUREMENT DATA INTO THE SIMULATION WORKFLOW FOR BLOW-MOLDED PLASTIC PARTS USING THE VMAP INTERFACE STANDARD

Prof. Dr.-Ing. Olaf Bruch^{1,2}, Patrick Michels², Daniel Grotenburg³

¹ Dr. Reinold Hagen Stiftung, Bonn, Germany

² TREE Institut, University of Applied Sciences Bonn-Rhein-Sieg, Germany

³ RIKUTEC Richter Kunststofftechnik GmbH & Co. KG, Altenkirchen, Germany

Extrusion blow molding is the standard process for manufacturing hollow plastic parts. The product range extends from consumer and industrial packaging (bottles, canisters, IBCs) to complex technical parts such as vehicle tanks. The specific properties of the final products are closely linked to the manufacturing process and include local variations in wall thickness, fluctuating material properties and anisotropy.

In recent years, a sophisticated CAE workflow has been developed to predict the complex behavior of blow molded components. This workflow integrates various simulation tools for both process and structural analysis and utilizes the VMAP Interface standard.

Recent developments in the VMAP standard now offer the possibility to incorporate measurement and sensor data into the CAE workflow. Consequently, the simulation results can be directly validated in comparison to actual measurements. At the same time, measurement results, such as the temperature distribution determined by thermography or the wall thickness distribution obtained by CT or 3D-Scanning, can serve as the basis for further simulation steps.

FURNACE MODELLING - SHARING THE EXPERIENCE FOR DATA ANALYTICS AND MODELLING IN THE STEEL PRODUCTION DOMAIN

*Krister Ekström, Stefan Marth, Johan Lindwall, Tania Irebo Schwartz, Sivaprasad Palla
Swerim AB, Sweden*

Digitalization, driven by key enabling technologies like sensors, big data, artificial intelligence, internet of things, automation, and digital twins, is a key factor in advancing manufacturing. The VMAP-analytics project aims to create a smart digital twin platform, integrating sensors, measurement data, process modeling, and data science tools. With three specific use cases in Sweden, and one in Germany, the project focuses on developing new expertise and business models for optimized production.

Three use cases of Sweden in this project involve a deeper understanding of manufacturing processes that include reheating furnaces, degassing of steel making and hot rolling for flat products. This presentation focuses on reheating furnace use case to support in development of a better Furnace Optimization and Control System (FOCS). Towards this end, physics-based and data-based models are developed.

The presentation discusses various aspects of modeling, the preparation of data and the application of XGBoost algorithm for analytics. The following suggestions are made from this project:

- Availability of sensor data for boundary conditions for the physics-based models.
- Availability of data for validation of physics-based models
- Ontology and semantics for sensor data
- Handling industrial data

The importance of VMAP standards and their applicability is emphasized.

VIRTUAL MANUFACTURING VALIDATION DATA IN COMPOSITE PRODUCTION

*Martin Rädels, Jean Lefèvre, Andreas Schuster
Institute of Lightweight Systems, Structural Mechanics, German Aerospace Center DLR e.V.,
Braunschweig, Germany*

In the DLR Virtual Product House (<https://dlr.de/vph>) simulation-based end-to-end processes for virtual sizing, manufacturing, and testing are developed. The coupling of these assessment steps allows a risk mitigation in product development processes as certification-relevant effects can be detected earlier and fed back to the design and decision making. Part of the development of this end-to-end process is the verification and validation of different product stages, especially during manufacturing and testing. Optical measurements of the physical products are used to validate the simulative predictions. These measurements can either originate from structured-light 3D scanning and comparison to a reference geometry or digital image correlation and tracking measurements.

The usage of the measured manufacturing deformation data is two-fold. For once, it is used to validate the simulative predictions, e.g., process-induced deformations of composite materials. On the other hand, real-world measurements are mapped onto a structure to improve the accuracy of virtual testing, where initial deformations may have a significant effect on the strength and stability behaviour of thin-walled composite structures in aerospace applications. This data is usually static, meaning there is one measurement for a static condition after any manufacturing step.

On the other hand, deformation data is obtained during the testing of lightweight structures, either as a full-field measurement using digital image correlation of a special pattern on the structure or for singular markers optically measured at certain specific locations. This data is transient for a certain measurement resolution during a test.

Both information types are measured on the actual structure. Generally, information types may be displacements, velocities, accelerations and other vectorial or scalar information for any number of discrete coordinates in a reference coordinate system.

ARCHIVING OF DATA SETS IN THE NDT (NON-DESTRUCTIVE TESTING)

*Frank Leinenbach,
Fraunhofer Institute for Nondestructive Testing IZFP, Saarbrücken, Germany*

Generic and standardized data formats are an essential basis for achieving the digitization of NDE in the sense of NDE 4.0. These allow manufacturer-independent data exchange and guarantee the use of data sets for decades to come. This goal has led to various attempts at implementation over the last few decades, only a few of which are still in use today. One standard that is widely used is the DICONDE data format. In this article, the requirements of the NDE with regard to data formats are presented, possible solutions are shown and current application possibilities but also current limitations of DICONDE are discussed.

ULTRASONIC GUIDED WAVES DATA IN SHM DESIGN

*Jean Lefèvre, Martin Rädels, Andreas Schuster
Institute of Lightweight Systems, Structural Mechanics, German Aerospace Center DLR e.V.,
Braunschweig, Germany*

Over the last years a lot of scientific work has been done in the field of structural health monitoring (SHM) systems. Instead of checking structures at regular intervals during a maintenance, future structures will be equipped with online monitoring systems. SHM also offers the possibility of saving weights going along with other advantages, e.g., decreasing fuel consumption in vehicle applications. In the case of thin-walled lightweight structures as they are commonly used for aerospace applications, SHM concepts based on ultrasonic guided waves are very promising. But large experimental efforts are needed to bring SHM systems into application.

The large experimental effort of designing SHM systems can be significantly reduced by accompanying simulations. Bringing together experimental and numerical data is important by two reasons. At first, test data is needed to validate numerical simulation methods. Subsequently, these simulation methods can be used to investigate the performance of proposed SHM configurations.

To show a suitable modelling strategy, ultrasonic guided waves simulations using the finite element method (FEM) are presented. As a reference model the measurement data coming from the Open Guided Waves Project (<http://openguidedwaves.de>) is taken into account. Experimental data of ultrasonic guided waves propagation in carbon fiber composite plates with an additional omega stringer is provided here.

The finite element data standard VMAP and its extension to sensor data handling can be introduced to SHM design purposes. Hence, the comparison of theoretical and experimental data is simplified. This is also of great importance regarding post processing procedures like visualization, KPI estimation or any other data transformation in general.

SCALABLE PRINCIPLES FOR INTEGRATION PIPELINES OF SENSOR DATA AND SIMULATIONS USING KNOWLEDGE GRAPHS

Morten Meyer

SICK AG – Think Tank, Waldkirch, Germany

Providing FAIR data internally and externally is currently an important challenge for industry. VMAP, as a data standard for the transfer of data between engineering simulation tools, addresses interoperability and for the simulation domain, not unlike some standards do for sensors. We consider VMAP as part of a broader landscape: data is context-dependently required in different forms – but identity and meaning of the data itself does not change! At the example of one scalable VMAP processing architecture, we provide an overview that highlights important principles for integration of distributed data in a FAIR open world approach:

- Distributed data architecture: a data mesh with a knowledge graph that orchestrates different "perspectives" is powerful. For scaling, the enterprise's architecture must account for the fact, that knowledge domains have their own life cycle.
- Explicit meaning is crucial: at SICK, we introduced a core ontology - the SICK Application Model (SAM) for this purpose. VMAP represents what we call a 'Profile', i.e., a contract between interfacing functionalities that defines the meaning and structure of their provided or consumed data.
- Separation of meta-levels of identity and representation of data sources: A VMAP file itself is embedded in a broader application context and embodies some specific content. We can address questions about infrastructure as well as questions concerning the domain that depend on the meaning of the data object, e.g., "where can I find the temperature physically", vs. "what is temperature", both address semantic representations.
- There is only one source of truth. This reflects explicit responsibilities for data. Source data bases are sources of truth and data can only be transformed in formal processes since there must not be a second component with the same rights. One can, of course, transfer aspects the responsibility under given circumstances.
- Data pipelines like ETL are nothing but one exposure option among many. To have a second kind of exposure in this example, we can use a virtual knowledge graph for VMAP.
- Storage is not the same as access. The physical storage location and low-level management of data objects is a secondary feat for the integrator, as long as the data pipelines are built on FAIR principles and the semantics is explicitly defined. It is a primary concern only for those systems that drive the efficiency of CRUD operations

at scale. Time series data, for instance, will always be stored in a different native data base than document-based data.

- Components that serve or consume data are also data objects and should be FAIR. This means that, as far as possible, micro-service-based architectures should be used for the tooling landscape. This suggests the benefit of a gateway that can expose data as VMAP for different native management systems. Following this logic, we outline a possible reference architecture for VMAP document stores for future community discussions.

VMAP-ENABLED MULTI-DISCIPLINARY COLLABORATION ON JET ENGINE DESIGN

Oliver Kunc,
Institute of Structures and Design, DLR (German Aerospace Center), Stuttgart, Germany

We present applications of the VMAP Standard in the field of gas turbine aero-engines. The utilization of VMAP enables the transition from conceptual/preliminary design to higher fidelity design in a sustainable and scalable way. After providing information on the context of engine development at DLR, we elaborate on concrete use cases of VMAP.

Engine design at DLR

The basis of many activities around engines at DLR is the software platform “GTlab” (Gas Turbine Laboratory). A **central data model** (CDM) is at its core. This model allows for the parametric lower-fidelity description and hierarchical representation of major engine components.

Modules of diverse disciplines provide **processes** that interact with the CDM. Here we present the novel integration of **VMAP files** and **CSM processes** into the ecosystem.

VMAP use cases

1. Blade-to-Blisk (bladed disk)

This initial process creates two VMAP files and attaches them to the respective components of the CDM. Multiple interactions with other, parametric elements of the CDM also take place.

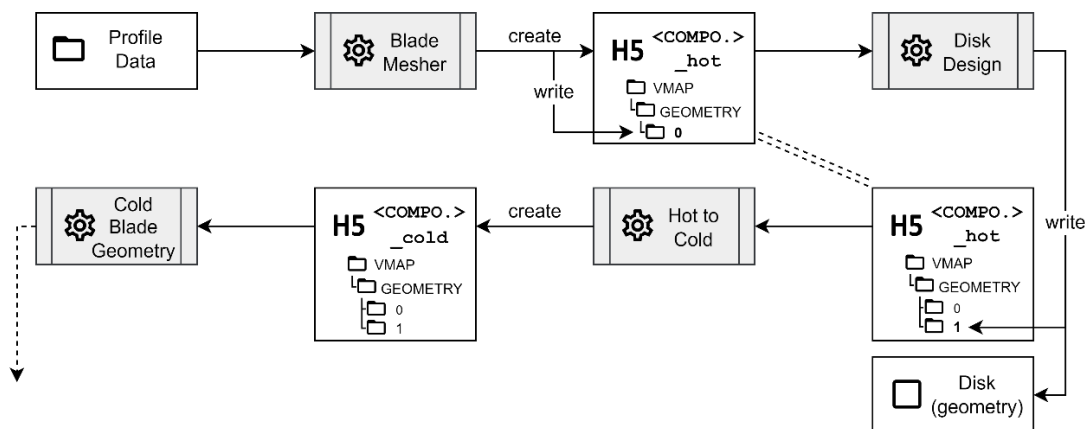

Figure 6: Standard process, creating two VMAP files.

2. Static FSI (Fluid Structure Interaction)

An equilibrium state between the rotor blade and its surrounding fluid is found by means of an iterative procedure. In each iteration, the corresponding VMAP file attached to the CDM is read and modified. Feedback to other parts of the CDM is possible, depending on the outcome of the FSI.

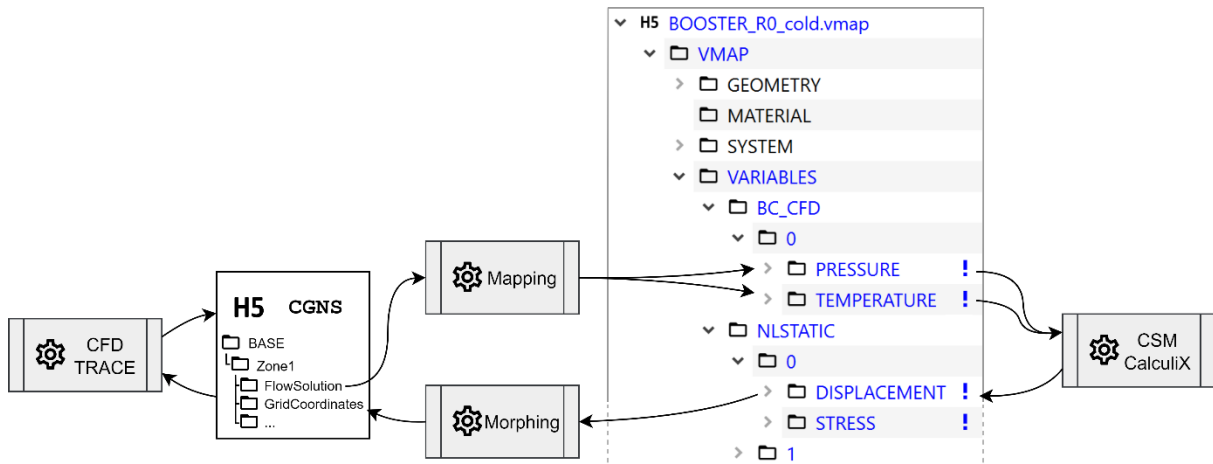

Figure 7: Iterative FSI process.

3. Other processes

Other examples of VMAP-enabled higher-fidelity CSM processes include but are not limited to:

- Modal FSI
- Modal analysis
- Foreign Object Damage (e.g. birdstrike)
- Pre- and post-processing of VMAP models and results inside a dedicated Mesh Viewer in GTlab

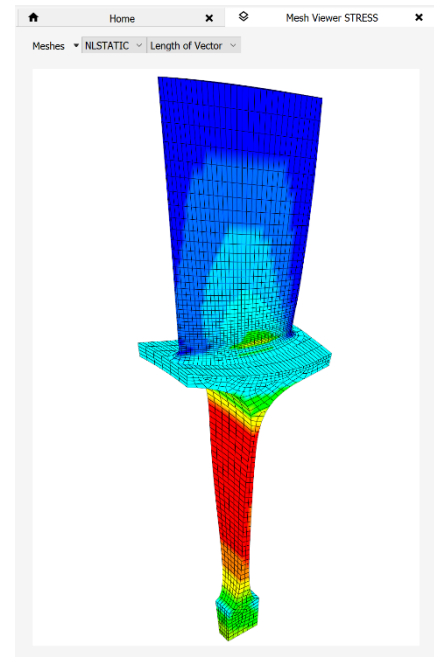

Figure 8: GTlab's Mesh Viewer prototype displaying VMAP data.

SEMANTIC CONCEPTS TO STORE AND ACCESS VMAP-BASED SIMULATION DATA

Philipp Spelten^{1,2,3}, philipp.spelten@phd.h-brs.de

¹ Fraunhofer Institute for Algorithms and Scientific Computing – SCAI, Sankt Augustin, GERMANY

² PROSTEP AG, Darmstadt, Germany

³ Institute of Technology, Resource and Energy-Efficient Engineering (TREE), Bonn-Rhein-Sieg University of Applied Sciences, Sankt Augustin, Germany

Integrating physical simulation data into data ecosystems challenges the compatibility and interoperability of data management tools. Semantic web technologies and relational databases mostly use other data types, such as ERP or design data.

VMAP as an industrial standard offers novel possibilities when compared to other standardization approaches such as the archival-oriented ISO standard STEP (ISO 10303” Standard for the Exchange of Product model data”). While the latter has included simulation data in its CAD modules, this has not proven feasible in industry contexts. On the other hand, enhancing VMAP with semantic capabilities promises to finally bridge the gap between product and simulation data management (PDM and SPDM).

This presentation showcases a prototype of a new application methodology based on VMAP. The architecture integrates access and analysis processes for large quantities of structured simulation data. This enables data permeability from the global digital twin level (i.e., ERP, design, measurement data, etc.) to the detailed numerical values of data entries (i.e., singular values or post-processed key indicators) in a three-step approach: (1) A file is represented in a knowledge graph, (2) the file’s metadata is queried, and (3) access and analysis processes are represented semantically and are thus found in the knowledge graph and executed to create and instantiate new metadata.

THE APPLICATION OF THE VMAP STANDARD IN VIRTUAL PROCESS CHAINS FOR CONTINUOUS FIBER REINFORCED POLYMERS

Constantin Kraus

Karlsruhe Institute of Technology (KIT) - Lightweight Engineering, Karlsruhe, Germany

Distinguished by their exceptional weight-specific mechanical properties, continuous fiber reinforced polymers (CoFRP) stand out as ideal materials for use in load-bearing components within the automotive and aviation sectors.

The macroscopic composite properties are determined by a multi-step manufacturing process. This typically involves an initial draping step, followed by the infiltration of liquid resin, and the thermo-chemical curing reaction within the mold. Depending on the component's shape, process parameters, and boundary conditions, significant variations in local fiber directions and constituent composition may arise within the part, leading to global and local deviations from nominal mechanical material properties.

Recognizing the potential impact of manufacturing effects on the final product, it becomes crucial to consider these effects during the component design phase. This can be achieved through a CAE chain that interlinks the various simulation modules, which are tailored to the physics, constitutive material law, and suitable discretizations of the specific process steps.

This talk focuses on the interfaces between these individual simulation modules, their implementation, and the challenges associated with them. The application of the VMAP specification and the utilization of its software library for implementing interoperable Input/Output tasks with third-party software are showcased through examples involving automotive and aviation components manufactured in the resin transfer molding process.

STANDARDIZED SIMULATION WORKFLOWS IN THE AUTOMOTIVE INDUSTRY

Bastian Näser¹, Jörg Rademann², Darius Friedemann²

¹ BMW Group, Munich, Germany

² Hochschule für Technik und Wirtschaft Berlin, Berlin, Germany

Today, products of a certain complexity must meet a wide range of functional requirements. This is reflected in the current virtual development process. The simulations of the different engineering disciplines are carried out in parallel and in certain cases also sequentially. In this case, the output of the previous simulation is often the input for the subsequent simulation. An example for this is forming simulation, which leads to internal stresses and changes in sheet thicknesses. This material progression has a significant impact on the results of NVH or strength simulations.

Standardized formats are preferred for exchanging simulation data. The established VMAP format can be used for the storage and transfer of simulation results. This format is supported by various solvers and preprocessors. SMILE (Unified Simulation Modeling Language), which describes the geometric and physical properties of the simulation object independently of the solver and the simulation discipline, is recommended for exchanging simulation models. Numerical know-how is incorporated into the solver dependent simulation input file during the translation process. Therefore, machine-readable modeling guidelines are provided by simulation experts and used in the workflow.

In this presentation the concept of the Unified Simulation Modeling Language (simulation model and modeling guidelines) on different examples in the NVH and crash simulation disciplines is presented. Moreover, three different ways on how to combine SMILE and VMAP in a workflow for crash and NVH simulation in the automotive industry is demonstrated.

PROCESS AUTOMATION FOR CAE ENGINEERS

Andrew Sartorelli
Synera GmbH, Bremen, Germany

Learn how Synera has leveraged VMAP and other open formats to create a vendor agnostic automation platform for engineers. We'll dive into a use case where we automate the CAE analysis of a component from design through to final part cost calculations.

PROJECT PIONEER - OPEN PLATFORM FOR OPTIMISING PRODUCTION SYSTEMS

*Mónica Salgueiro
AIMEN, Spain*

Project Pioneer Consortium: AIMEN, ESI, Engineering Ingegneria Informatica, Limitstate, EBBAMS, TTP, Fankom, Tekniker, ENSAM, Imperial College London, University of Patras, CORE Innovation Center, FhG SCAI, IRES, CLESGO, Marelli, MX3D

European manufacturing enterprises are facing several challenges in a turbulent globalized market dealing with unprecedented and abrupt changes in market demands, an ever-increasing number of product variants and smaller lot sizes, intensifying the worldwide competition and causing a continuous pressure on production costs. This results in large-scale fluctuations of demand, increasing product variants with specific configurations, random dispatching of orders, short delivery lead times of products and shortened product life cycles. Traditional approaches, which consist mostly of rigid, hierarchical manufacturing architectures, have been unable to deal successfully with these upcoming challenges, because the production management become ineffective in a small series manufacturing approach. Therefore, the shift to mass production tailored to customer demands requires new methods and concepts. In this sense, although the benefits of digital-powered manufacturing approaches are widely accepted, their implementation remains a challenge, especially for SMEs.

PIONEER aims the development and implementation of an interoperable Materials-Modelling-Manufacturing Ecosystem enabling multidirectional dataflow along the material value chain, by linking product design and distributed modelling data, with information collected from material characterization, manufacturing processes and product quality criteria. PIONEER combines design-by-simulation approach (by relying on multidisciplinary and multiscale modelling) with manufacturing and quality data, for optimizing product development strategies in high-mix/low-volume production schemes.

One of the key features of PIONEER is the development of a common simulation/modelling methodology framework to ensure data exchange along engineering workflows. To do that, interoperable data formats across distributed simulation/modelling suites are needed to enable engineering workflows.

VMAP as vendor neutral standard will be extended to support models and material information on multiple scales. VMAP allows a seamless data exchange of material and engineering data across different CAE software along virtual engineering workflows.

The solution will be validated in two different manufacturing scenarios by involving multidisciplinary optimization for ensuring certified path planning strategies for the manufacturing of topology optimised structural elements through Wire-Arc Additive

Manufacturing (WAAM) in construction –i.e., low-volume production schemes–, as well as for ensuring an efficient design and manufacturing strategy for the manufacturing of Carbon Fibre Sheet Moulding Compound (CF-SMC) components in automotive –i.e., high-mix production schemes.

INTEGRATED DESIGN PROCESS FOR FLEXIBLE ELECTRONICS USING VMAP

*Nico Arnold,
TU Dresden/IFTE, Dresden, Germany*

*Edwin Lamers, Lambert Russcher
Reden, Hengelo, Netherlands*

Project HyperStripes Consortium: TU Dresden, Reden, Capical, FhG EMFT, Gdansk Uni, IMS CHIPS, ISS RFID, Integer, IMR, NanoWired, OSYPKA, Philips Healthcare, Salvia, SMG, Signify, TNO, Würth

The EU project HyPerStripes aims to develop long, flexible, and stretchable electronic stripes that can be used to create smart cables, medical implants and transparent displays on many different substrates. To meet the requirements, technologies like roll-to-roll manufacturing and chip embedding are used to facilitate a stable and cost-efficient production and small dimensions.

These stripes are mainly designed using classic PCB programs, with the biggest support being for KiCad. The flat geometries exported from these applications are extruded to create 3D shapes, which are then transformed to bend these designs into their final shape. This is done by a program developed for bending those 3D geometries just like a normal flexible circuit. Based on the data generated by that program, different simulation steps can be carried out to verify the usability of the design for the respective application.

Since many steps are involved in the interdisciplinary design, simulation, evaluation, production and testing, there is a need for a file format that is able to store information about all the process steps involved. The VMAP format is able to fill this gap by offering the possibility of saving datasets, geometries, simulation results and measurement series while providing the option of adding meta information to the data it contains.

PROJECT METAFACTURING - DATA AND METADATA FOR ADVANCED DIGITALIZATION OF MANUFACTURING INDUSTRIAL LINES

Diana Rodrigues

European Federation for Welding, Joining and Cutting, Porto Salvo, Portugal

Project Metafacturing Consortium: KU Leuven, Austrian Institute of Technology, Ghent University, RISC Software GmbH, EWF, Fronius, Nematik, BENTELER, Vitronic, Fill, ISQ, LTH Castings

The MetaFacturing project, supported by the European Union, and the VMAP standards both share a mission to advance digitalization and sustainability in the industrial manufacturing sector. MetaFacturing focuses on revolutionizing metal part production through the implementation of Digital Twin (DT) technology in a digitized toolchain. This initiative aims to enhance resilience by incorporating recycled materials, reducing operator effort, cutting costs, and minimizing scrap from out-of-specification parts. Simultaneously, the VMAP standards seek to establish a comprehensive platform for digital manufacturing and automation, emphasizing the importance of interoperability, data integration, and efficiency across diverse manufacturing processes. Both underscore the pivotal role of digitalization in optimizing manufacturing operations. MetaFacturing's emphasis on leveraging data—from material properties to end-of-line quality control—aligns with the broader goals of VMAP to establish standardized data formats and protocols. This alignment is crucial for seamless communication and data utilization across various manufacturing systems, fostering interoperability and efficiency. Another common interest is model-based data fusion, with MetaFacturing employing state-of-the-art technologies for this purpose. The collaboration between MetaFacturing and market leaders in metal part production, including FRONIUS, NEMAK, FILL, VITRONIC, BENTELER, and LTH, mirrors the collaborative spirit promoted by VMAP standards. Effective collaboration is essential for ensuring the widespread adoption of digitalization and standardized practices in the manufacturing industry. Both initiatives contribute to the overarching goals of enhancing product quality, sustainability, and resilience in manufacturing. MetaFacturing's specific objectives, such as reducing waste and incorporating recycled materials, resonate with the broader sustainability agenda that may be addressed by VMAP standards. In essence, the alignment between MetaFacturing and VMAP standards creates a foundation for mutual reinforcement, driving advancements in the realm of digital manufacturing, interoperability, and sustainable practices across the industrial landscape.

PROJECT RESTORE - SUSTAINABLE REMANUFACTURING SOLUTION WITH INCREASED AUTOMATION AND RECYCLED CONTENT IN LASER AND PLASMA BASED PROCESS

Diana Rodrigues

European Federation for Welding, Joining and Cutting, Porto Salvo, Portugal

Project RESTORE Consortium: Dalforsån, Aerobase Innovations, FIAT, Cranfield University, EIT Manufacturing, Endurance, EWF, Flowphys, Fhg SCAI, GSMC, Industrialisation Des Recherches Sur Les Procede, Intellegens Limited, IRIS, Lucchini, MSC Scanning, Navtek, Parida, Phd Controlled Solutions, TVS, Welding Alloys

RESTORE revolutionizes remanufacturing for a Circular Economy, pioneering sustainable processes, materials, and digital tools. Addressing implementation challenges, it innovates cladding technologies, introducing a hybrid process for enhanced deposition rates. The project develops recycled content wire feedstock and a unique feeding system, promoting zero-waste practices. A decision support framework guides remanufacturing decisions, while the RESTORE platform digitizes operations, offering process automation, optimization tools, and blockchain-enabled product traceability. This comprehensive approach transforms industries by fostering resource efficiency, waste reduction, and a circular economy, empowering stakeholders for a sustainable future.

RESTORE's ambition to reduce waste aligns with VMAP's pursuit of eco-design principles, creating synergies in their objectives. The development of the RESTORE platform, with its tools for process automation, simulation, decision support, and a blockchain-enabled digital product passport, reflects a commitment to transparency and traceability, echoing the VMAP community's emphasis on disseminating results and promoting participation in standards. By fostering collaboration through virtual spaces, both initiatives recognize the importance of engaging stakeholders, showcasing a shared vision for a sustainable, circular economy. As RESTORE endeavours to optimize remanufacturing operations, it complements the VMAP Standards Community's aim to link virtual and real-world data, creating a harmonious partnership dedicated to scientific progress and the promotion of sustainable industrial practices.

PROJECT ALABAMA - ADAPTIVE LASER BEAM FOR ADDITIVE MANUFACTURING

Klaus Wolf

Fraunhofer Institute for Algorithms and Scientific Computing – SCAI, Sankt Augustin GERMANY

Project ALABAMA Consortium: Aerobase Innovations, FIAT, Flowphys, FhG SCAI, Fundacio EURECAT, GKN Aerospace Sweden, IRIS SRL, Luleå University of Technology, Manufacturing Technology Norwegian, Nordic Additive Manufacturing, SINTEF Manufacturing, Technovative Solutions Limited, FhG IWS

The ALABAMA project aims to develop and mature adaptive laser technologies for AM. The objective is to lower decrease the porosity and to tailor the microstructure of the deposited material by shaping the laser beam, both temporally and spatially, during the AM process. The key innovations in the project are to develop multiscale physics-based models to enable optimization of the AM process. These process parameters will be tested and matured for multi-beam control, laser beam shaping optics and high-speed scanning. To ensure the quality of the process, advanced online process monitoring, and closed loop control will be performed using multi spectral imaging and thermography to control the melt pool behavior coupled with wire-current and high-speed imaging to control the process. To verify that the built material fulfills the requirements, advanced characterization will be conducted on coupons and on use-cases.

The matured technology will be tested on three use-cases: aviation, maritime and automotive. These three industrial sectors span a broad part of the manufacturing volumes: from low numbers with high added value, to high numbers with relatively low cost.

However, all these sectors struggle with distortions, stresses, and material quality. The ALABAMA use-case demonstrators will improve the compensation for distortions during the AM process, reduce the build failures due to residual stresses, reduce porosity and improve tailoring of the microstructure. Overall, this will contribute to up to 100% increase in process productivity, 50% less defects, 33% cost reduction due to increased productivity and energy savings, a reduction of 15% in greenhouse gases and enable first time- right manufacturing thanks to simulation, process monitoring and adaptive control.

The end users will insert the technologies while the sub-technologies developed in the work packages will be commercialized. This will increase the autonomy for a resilient European industry.

One of the main aims of ALABAMA is to replace native formats with standards such as VMAP. ALABAMA-specific extensions and customizations for these data standards and corresponding semantic concepts (ontologies) are being developed and published. This means that previously separate data sources can be integrated into a standardized information management system and coordinated consistently.

PROJECT BASE - BATTERY PASSPORT FOR RESILIENT SUPPLY CHAIN AND IMPLEMENTATION OF CIRCULAR ECONOMY

Klaus Wolf

Fraunhofer Institute for Algorithms and Scientific Computing – SCAI, Sankt Augustin GERMANY

Project BASE Consortium: FhG IEG, Adscensus, Artech International, Aspilsan Enerji, BEEPLANET Factory, Corvus Norway, European Lithium Institute, Exitcom Recycling, Fondation Pour L Institut De Hautes Etudes Internc, Ford Otomotiv, Innd Batteries, Mercedes-Benz Turk, Navtek, Parakeet, Rok Metals, Seraph Consulting, SQM, Technovative Solutions, University Of Surrey, FhG SCAI, FhG ISE

The battery although is at its central role for green transitioning of the road transport, the current battery supply chain is lacking in traceability and sustainability, resiliency, and circularity aspects. Critical Raw Materials (CRM) are essential ingredients for battery manufacturing. The exploding growth of Electric vehicles driven by the climate neutrality policy objectives will create pressure on CRM supply chain and will increase the EU dependency for CRM on 3rd countries, resulting in decrease of competitiveness of the EU automotive and battery manufacturers. Implementation of the digital battery passport (DBP) concept in the battery value chain might resolve these issues.

The main goal of BASE project is to develop, validate and implement a working DBP service, as mandated by the “Regulation”, by exploiting the collected data via number of constantly evolving tools and methods, to ensure transparent, secure, and cost-efficient platform operation, by also catalyzing the growth of circular businesses. The BASE will develop transparent methodologies to calculate battery performance & ESGE indicators while ensuring traceability down to CRM level through the entire battery value chain.

In the physical domain this will be achieved through the mass balancing approach. For data management side, exploiting distributed ledger technology, the BASE will ensure built-in data authenticity verification, along the value chain, with no data duplication, avoiding data manipulation assuring privacy by design, with promoting data interoperability.

BASE will pursue the concept of digital twin targets in federated data spaces to track data from physical parts and materials across the supply chain lifecycle to enable data-driven use cases across all n-tier levels, each without jeopardizing data sovereignty. As part of this task, standardized data formats and vocabularies tailored to battery components, materials and their lifecycles will be defined.

INTEGRATION PLATFORMS FOR DIGITAL PRODUCT PASSPORTS

*Miah Raihan Mahmud Arman,
Technovative Solutions, Manchester, United Kingdom*

The presentation is focused on the concept of Digital Product Passport (DPP) and its role in promoting sustainable practices in a circular economy. It begins by highlighting the current state of resource consumption and its implications, emphasizing the need for a shift towards sustainable practices. The DPP is introduced as a framework or tool designed to track a product's entire lifecycle, aiding the transition to a circular economy. The presentation covers why the DPP is essential, its legal backing, and the expected timeline for its implementation across various industries. It also discusses the implications of DPP at a global level, especially considering EU regulations. The presentation then explains how businesses can prepare for DPP integration, emphasizing collaboration, data security, and adaptable reporting. Finally, it showcases how TVS is at the forefront of DPP technology and implementation. It highlights their expertise and approach towards bespoke DPP solutions and data management. At the end of the presentation, TVS will show a quick demo of the DPP-enabled Joint Industrial Data Exchange Platform (JIDEP) funded by Horizon Europe Research and Innovation under grant agreement number 101058732.

FAIR DATA IN PLATFORM MATERIALDIGITAL (PMD): ONTOLOGIES, SEMANTIC DATA INTEGRATION AND DATA EXCHANGE

Markus Schilling

Bundesanstalt für Materialforschung und -prüfung (BAM), Berlin, Germany

Following the new paradigm of materials development, design, and optimization, digitalization is the main goal in materials sciences and engineering (MSE) which imposes a huge challenge. In this respect, the quality assurance of processes and output data as well as the interoperability between applications following FAIR principles are to be ensured. For storage, processing, and querying of data in contextualized form, Semantic Web technologies (SWT) are used since they allow for machine-actionable and human-readable knowledge representations needed for data management, retrieval, and (re)use.

The project 'platform MaterialDigital' (PMD)¹ aims to bring together and support interested parties from both industrial and academic sectors in a sustainable manner in solving digitalization tasks and implementing digital solutions. Therefore, the establishment of a virtual material data space and the systematization of the handling of hierarchical, process-dependent material data are focused. Core points to be dealt with are the development of agreements on data structures and interfaces implemented in distinct software tools and to offer users specific support in their projects. Furthermore, the platform contributes to a standardized description of data processing methods in materials research. In this respect, selected MSE methods are semantically represented which are supposed to serve as best practice examples with respect to knowledge representation and the creation of knowledge graphs used for material data.

Accordingly, this presentation shows the efforts taken within the PMD project towards the digitalization in MSE such as the development of the mid-level PMD core ontology (PMDco)². Furthermore, selected results of a PMD partner project use case addressing data and knowledge management from synthesis, production, and characterization of materials are shown.

MODA AND CHADA: STANDARDIZATION AND DIGITALIZATION OF SIMULATION AND CHARACTERIZATION DATA IN MATERIALS SCIENCE

Yoav Nahshon, Berk Yildizgöner, Dirk Helm

Fraunhofer Institute for Mechanics of Materials IWM, Freiburg im Breisgau, Germany

In the landscape of materials science, achieving standardization is a key enabler for an efficient management of simulation and characterization data. This presentation introduces the MODA (Modeling Data) and CHADA (Characterization Data) frameworks, products of European initiatives, that were specifically developed for the documentation of simulation processes and materials characterization experiments in a standard and machine-readable manner. CHADA focuses on the documentation of laboratory characterization experiments, while MODA is dedicated to capturing the essentials of simulation processes. The standardization effort includes the creation of their semantic representation that is grounded in the Characterisation Methodology Domain Ontology (CHAMEO), which relates to the Elementary Multiperspective Material Ontology (EMMO).

Accompanied by a supporting ecosystem, engineers and material scientists can create, via a friendly user interface, digital objects for the procedures, protocols and the settings that were involved in the workflow. These objects are stored in a purpose-built dataspace in which they can be found and queried. A complementing data integration pipeline can be configured by users to link input and output data and process parameters to the CHADA and MODA objects.

In a vision where digital twins of materials are stored in a dataspace, in which the semantics of data is directly understood by the system, MODA and CHADA will play a key role for outlying the ways in which materials data has been acquired and produced, including steps such as sample preparation, mathematical models, and post processing.

STEP BY STEP TO A MODEL-BASED ENTERPRISE

*Jochen Boy,
PROSTEP AG, Darmstadt, Germany*

ISO 10303, the Standard for the Exchange of Product data (STEP), is the cornerstone for building a Model-Based Enterprise (MBE). The communities supporting this standard's continued expansion and stability are vital for its success. The presentation will show how STEP helps to consistently define complex products and their context, and how it connects to other standards to build an information model that is greater than the sum of its parts.

BECOME A MEMBER OF VMAP SC!

Learn how to join our community of engineering and scientific professionals. We are a community largely formed by engineers from mechanical and computational engineering domains.

Who is the VMAP standard aimed at?

You work as an employee or freelancer in the field of mechanical engineering or the integration of CAx tools. If you have a lot to do with the exchange of data between different tools in the field of virtual development and physical measurement, then you can benefit from the VMAP standard. Instead of having to work with many native data formats, the VMAP standard allows them to solve IO problems much more easily using a single open data format.

Who can join?

If you think, you can benefit from the VMAP Standard and contribute to the development & extension of the VMAP Standard, then we would be happy to hear from you. The VMAP SC is open to any institution from industry, software-domain, and academia as well as for natural persons.

How can I become a member?

Applications for Membership should be submitted in writing to the VMAP SC Board. The application of a legal person should state the name of the natural person designated to represent the applicant. The Association should be informed of any subsequent change in the power of representation. The short letter of intent should be written on the company (in this case applicant) letterhead. The VMAP SC will process your request promptly and will then be able to offer you membership.

What are my benefits?

Members of the VMAP SC can actively influence the long-term strategy and technical development of the standard at an early stage. Current developments, ongoing R&D projects and new extension approaches for the standard are presented, discussed, and finally voted on at the quarterly plenary meetings.

What's expected of a me?

Members of the VMAP SC are invited to quarterly plenary meetings. Technical documents (specifications, implementations, applications) are distributed before and after these meetings - members are asked to evaluate these documents and then contribute their constructive opinions at the meetings. Members are of course also invited to actively participate in individual working groups to help shape the standard and its extensions.

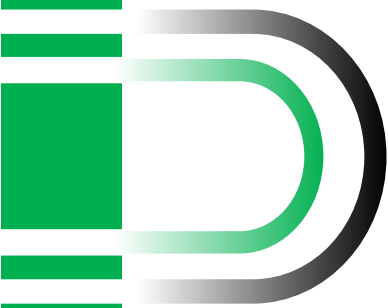

VMAP

Standards Community e.V.

Members



PHILIPS



SIMCON

inuTech



VMAP Standards Community e.V.

Fraunhofer SCAI
Schloss Birlinghoven 1
53757 Sankt Augustin
Germany

Website: vmap-standard.org
Email: info@vmap-standard.org